

Aruba 2B
Art. Nr. 4014510
1/15



24.01.2018

Art. Nr. 4014510

Groundplan - Grundplan - Plan de masse -
 Planimetria - Plattegrond - Põhiplaan

Foundation - Fundament - Fondation -
 Fondamenta - Fundering - Immutatud alusraam

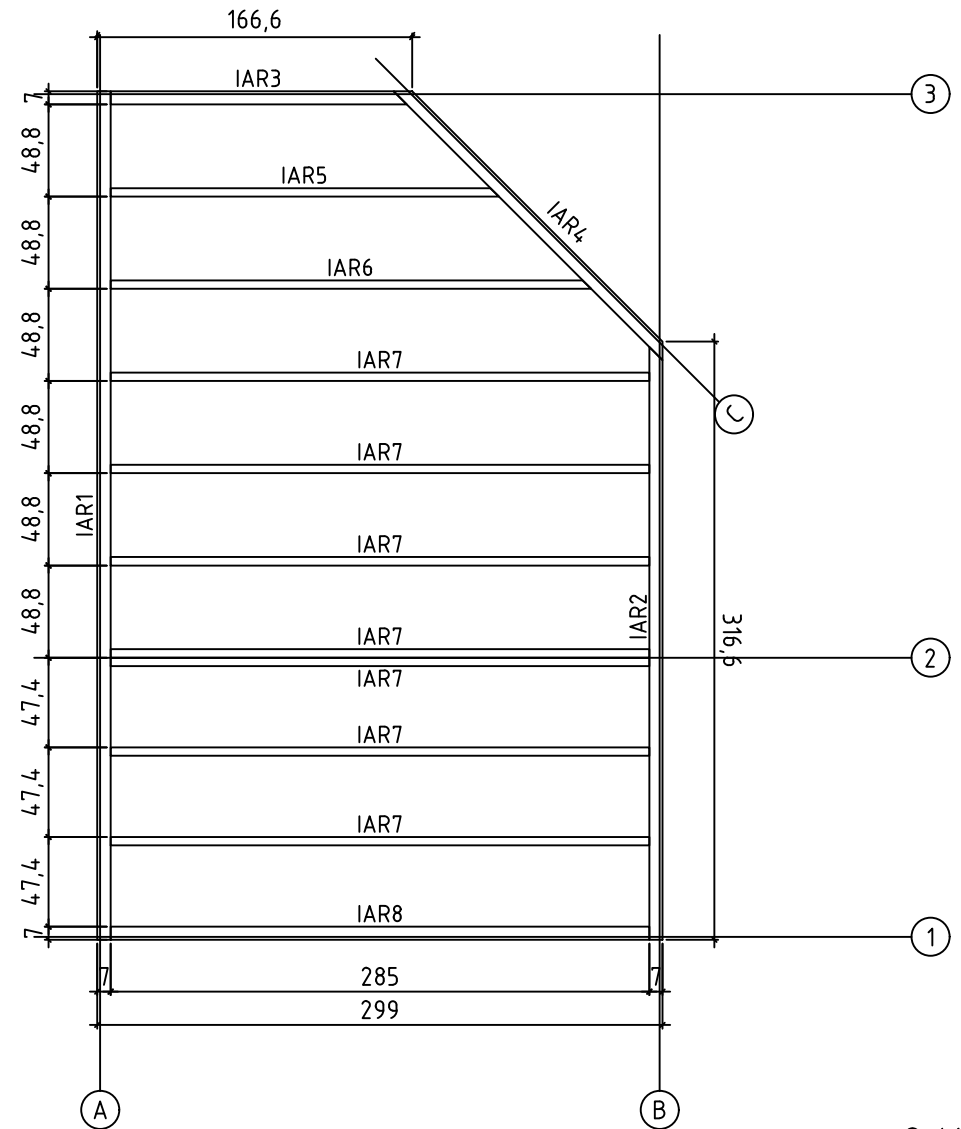
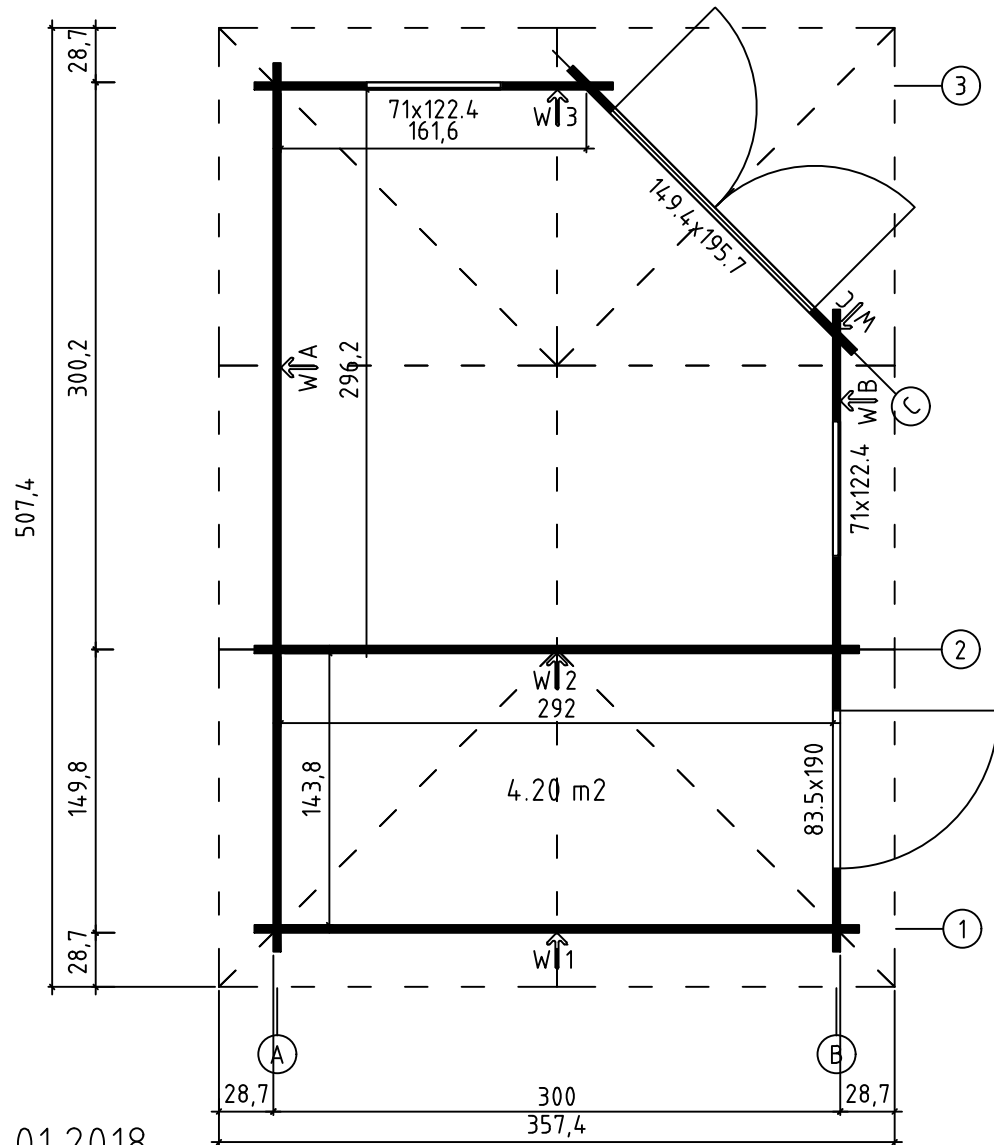

25.01.2018

2/15

Art. Nr. 4014510

Floor boards - Fussbodenbretter - Plan pose plancher - Roof plan - Dach-plan - Plan du toit - Piano del tetto -
Pavimento - Vloerhout - Põrandalaudis - Dak plattegrond - Katuseplaan

Mounting direction - Aufbauschritte - Instruction de montage -
Direzione di montaggio - Beverstingsrichting - Monteimise suund

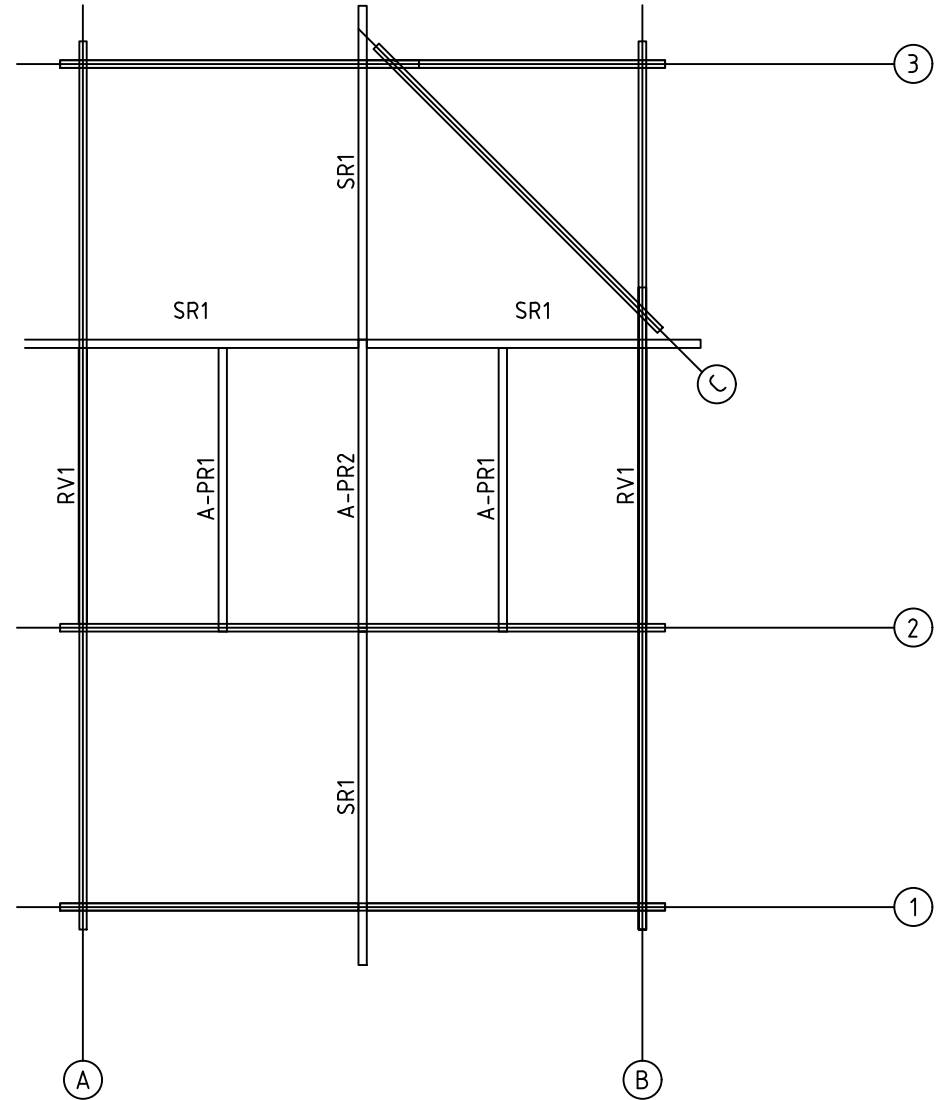
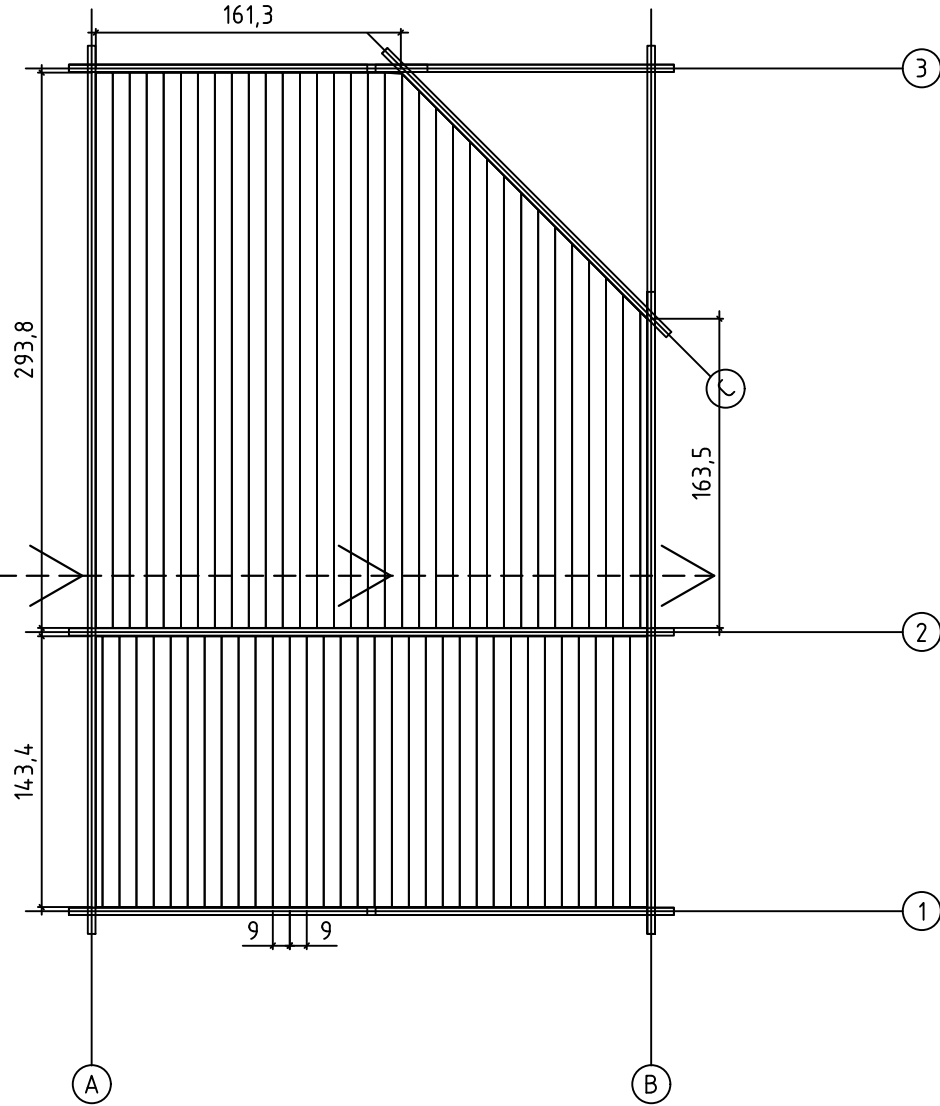

25.01.2018

3/15

Diagonals must be equal - Prüfung diagonale Austrichtung -
Controle des diagonales - Le diagonali devono essere eguali -
Gelijkbenige diagonaal - Diagonaalid peavad olema võrdsed
 $A=B, C=D$

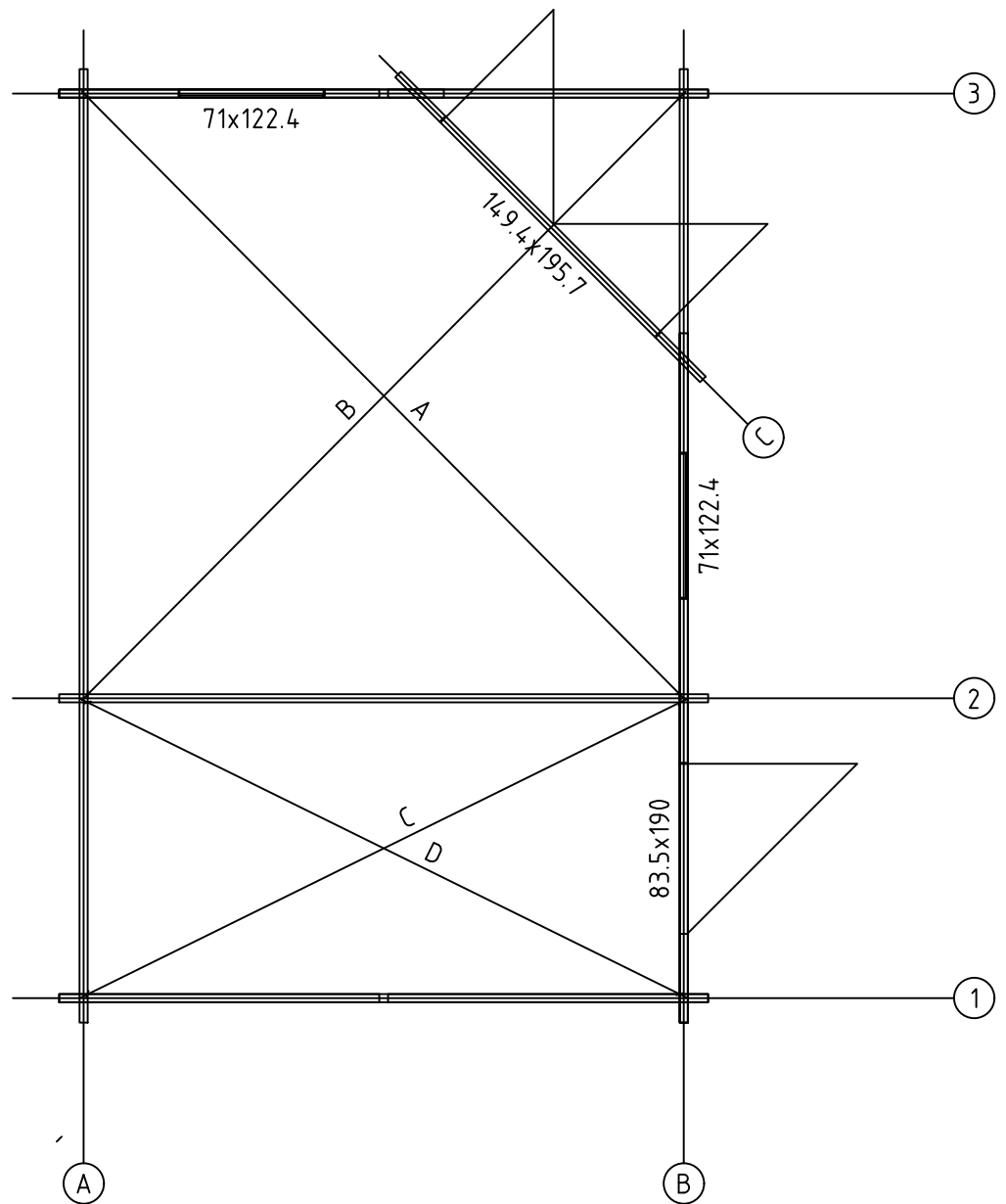

Art. Nr. 4014510

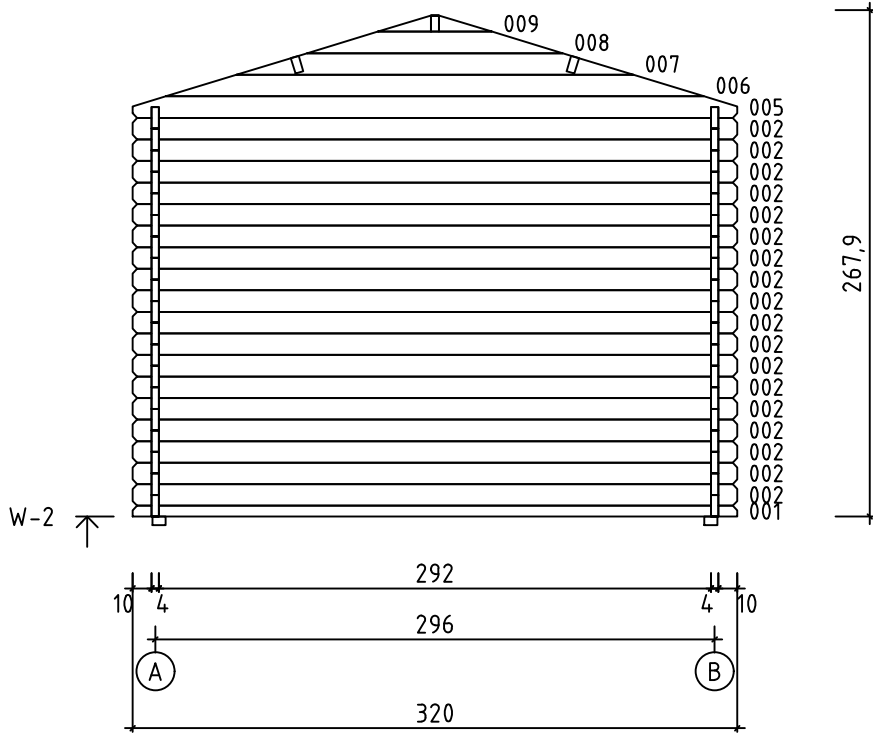
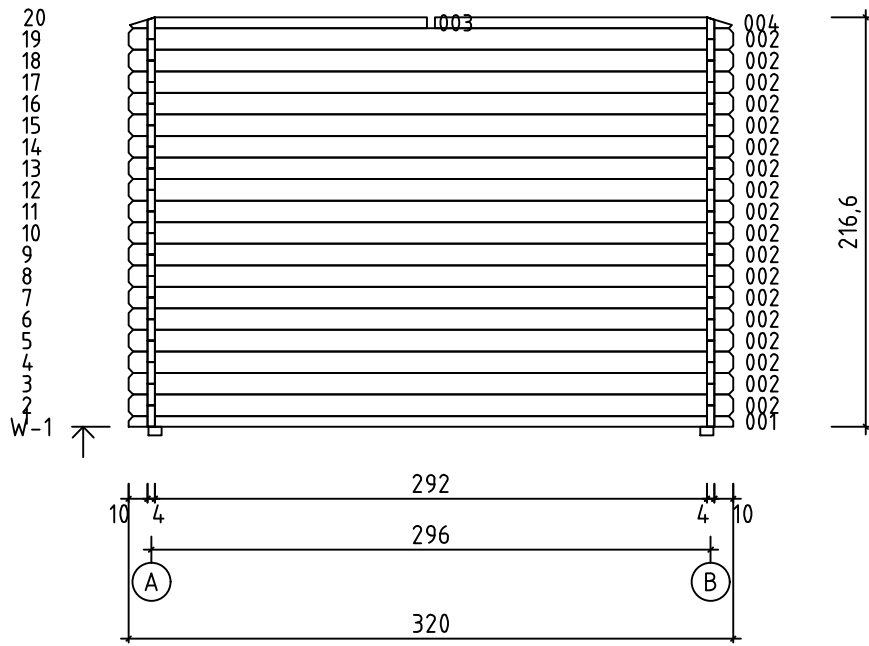

Art. Nr. 4014510

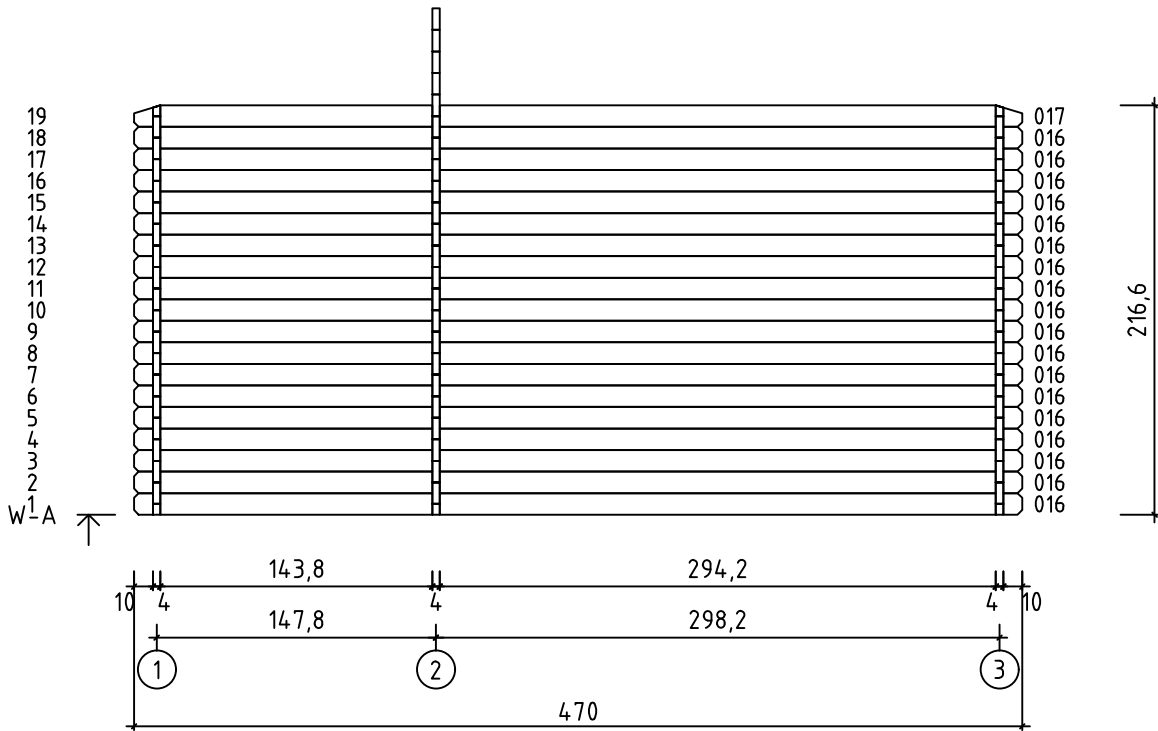
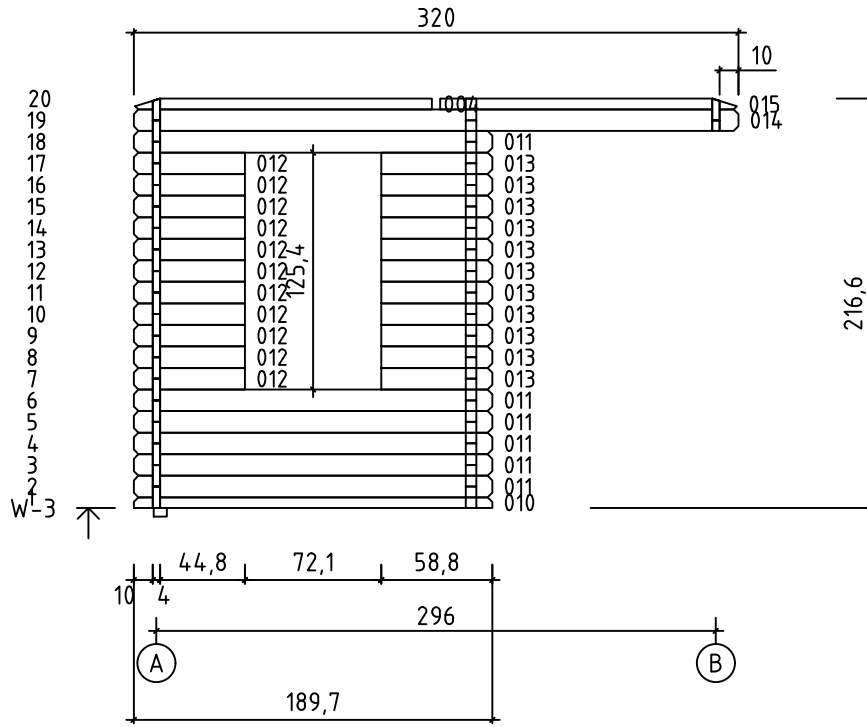

Art. Nr. 4014510

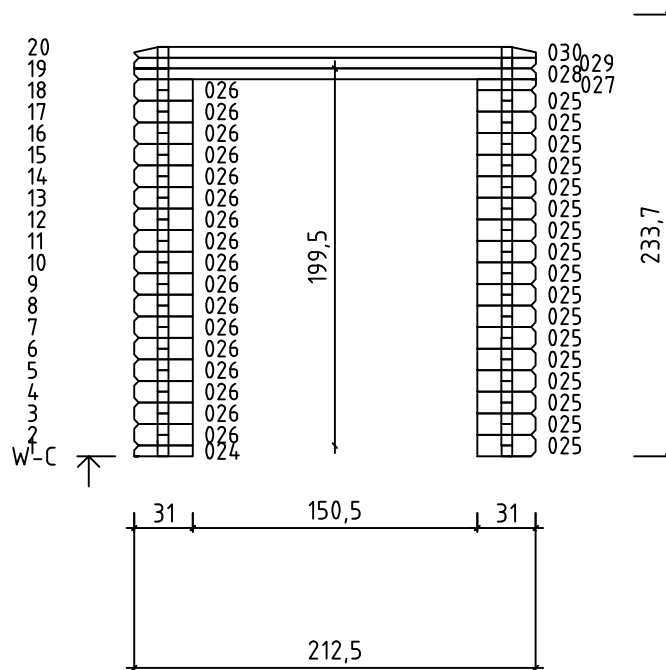
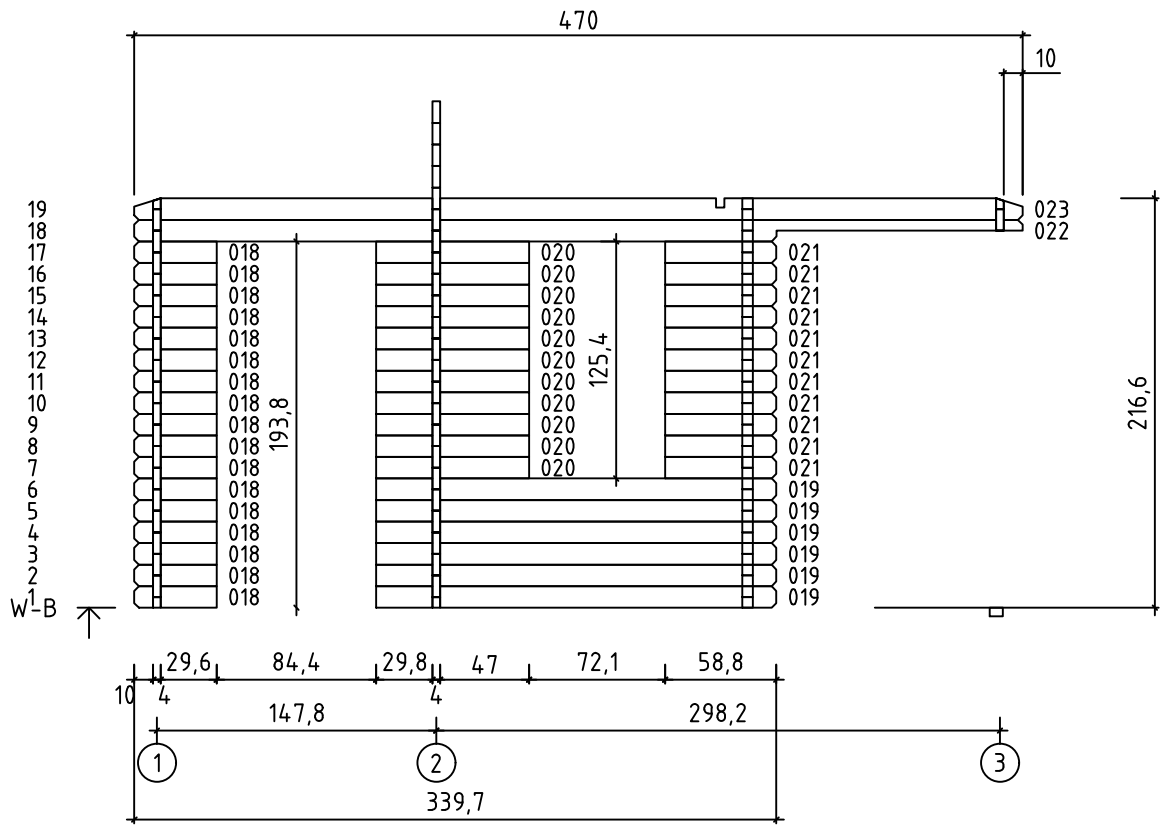

Art. Nr. 4014510

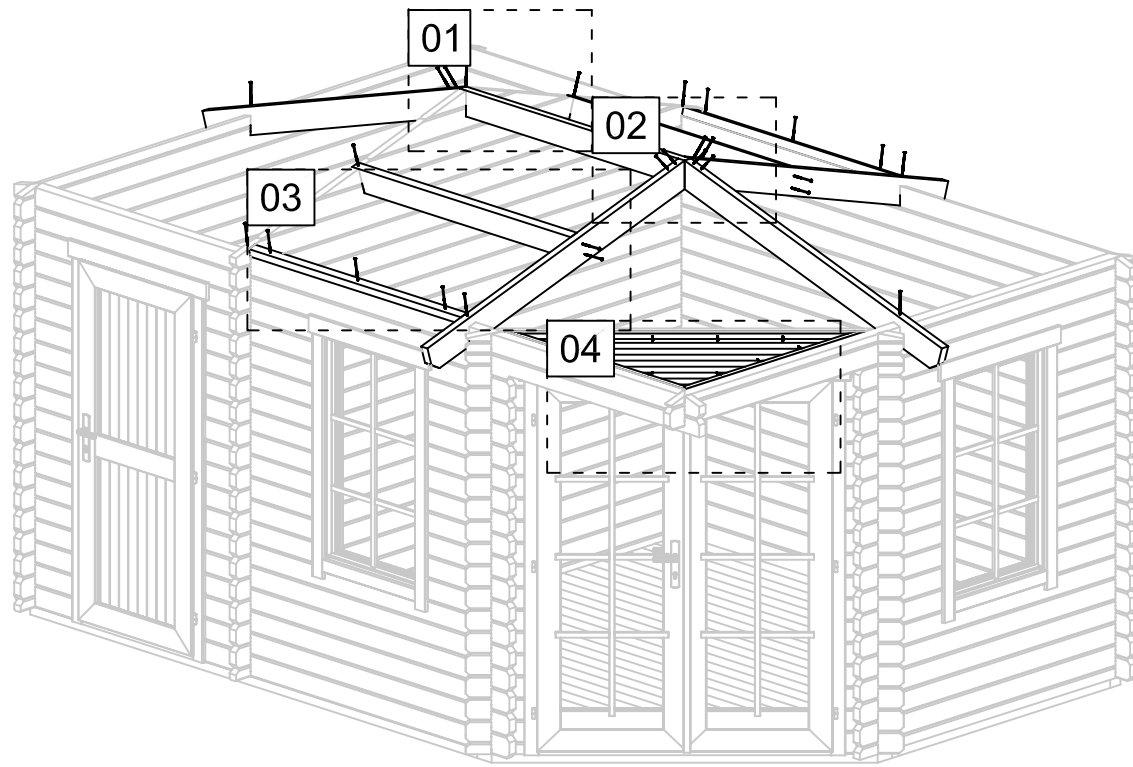

02

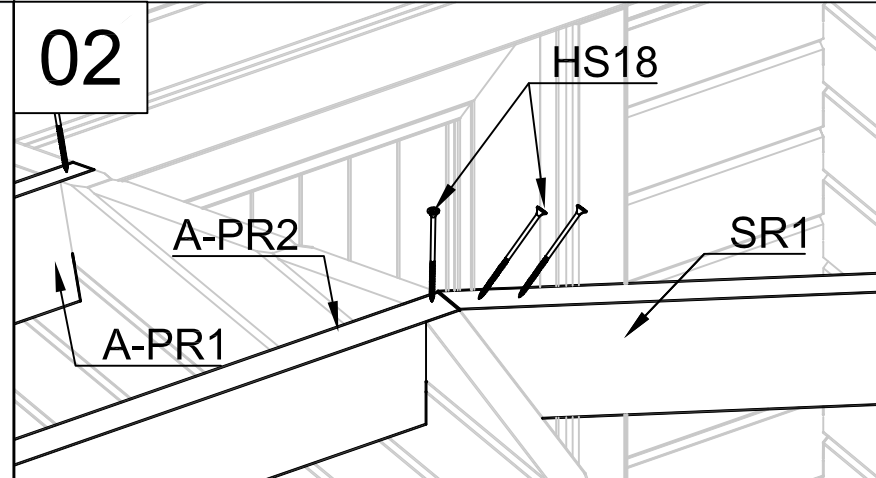

01

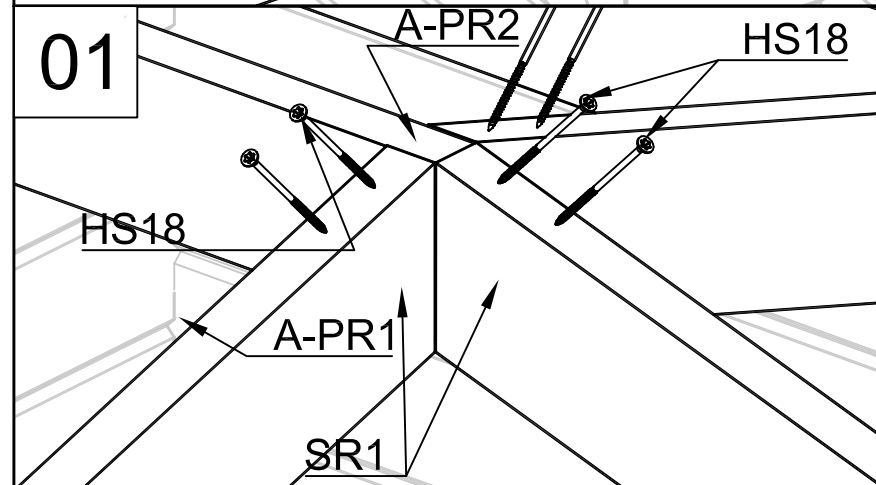

04

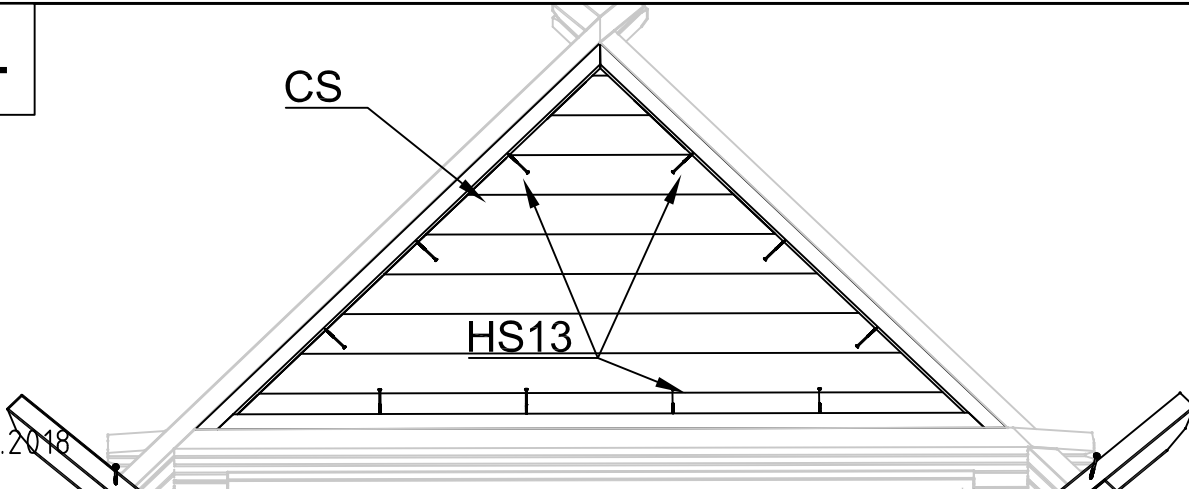

03

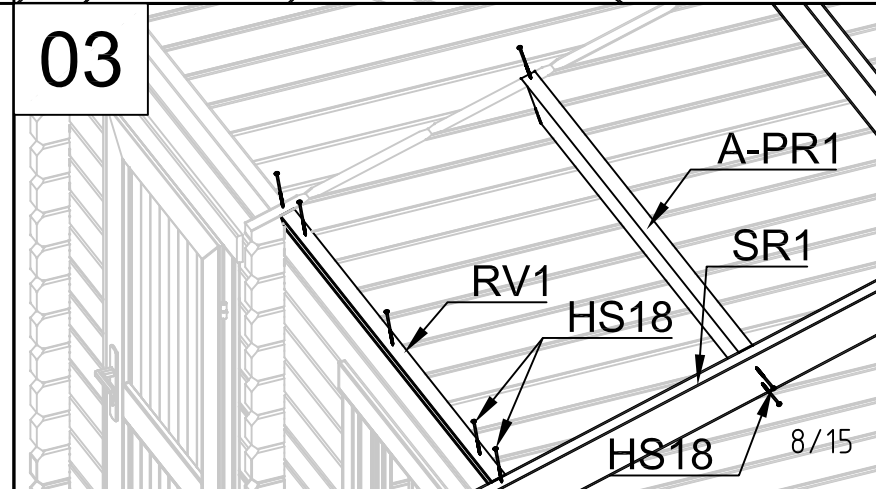

25.01.2018

8/15

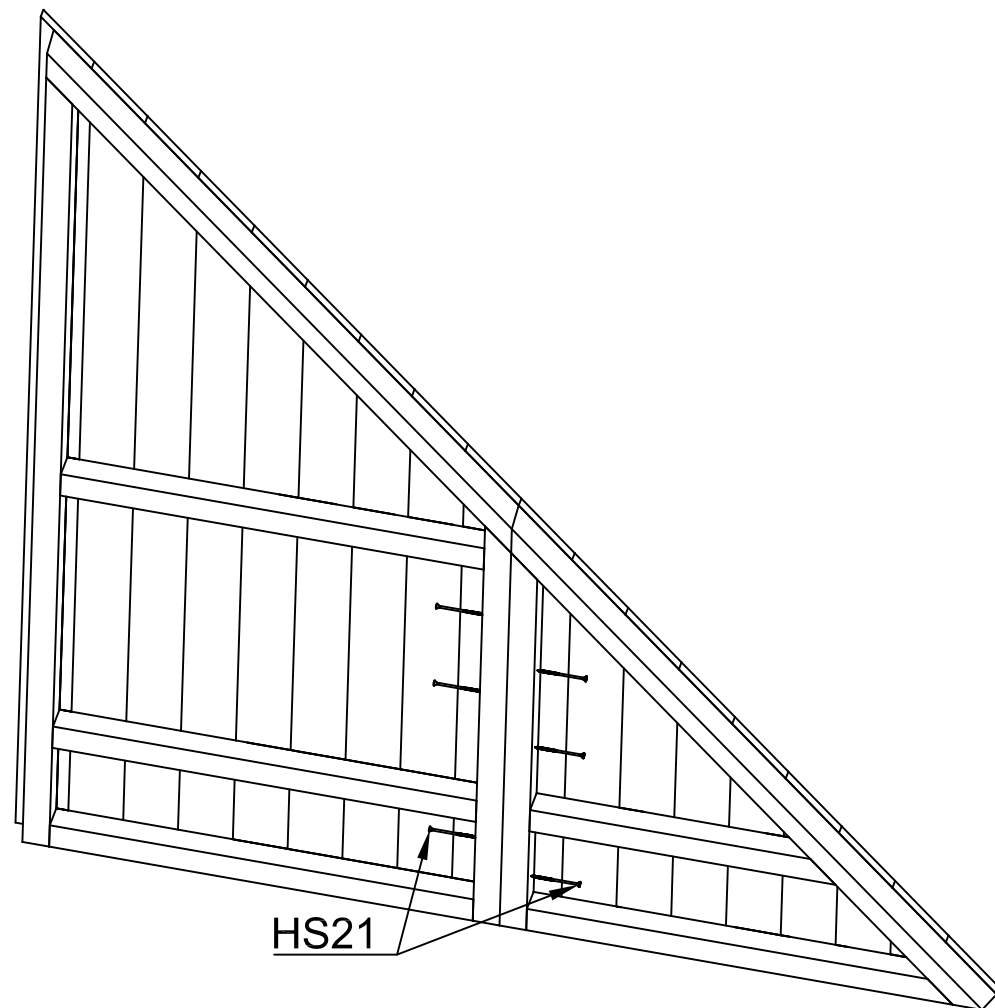
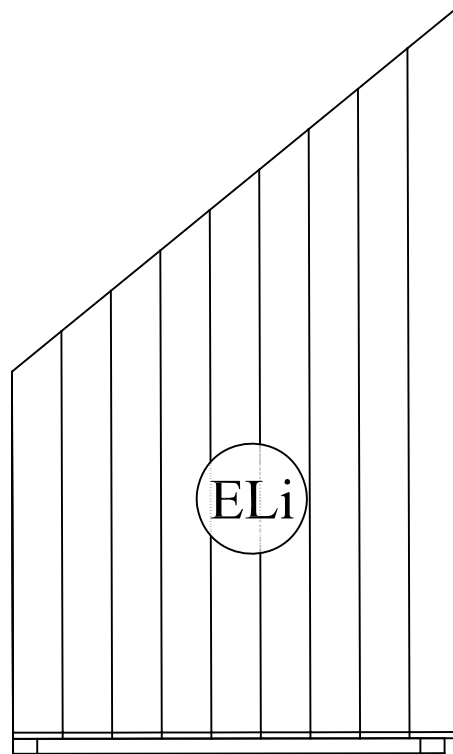
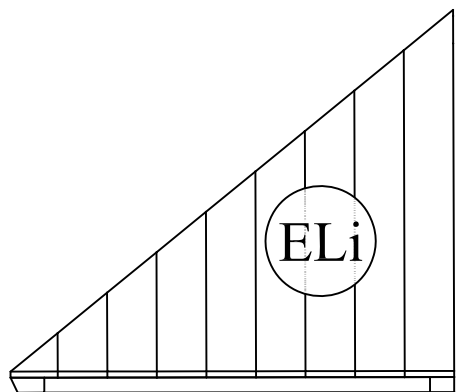

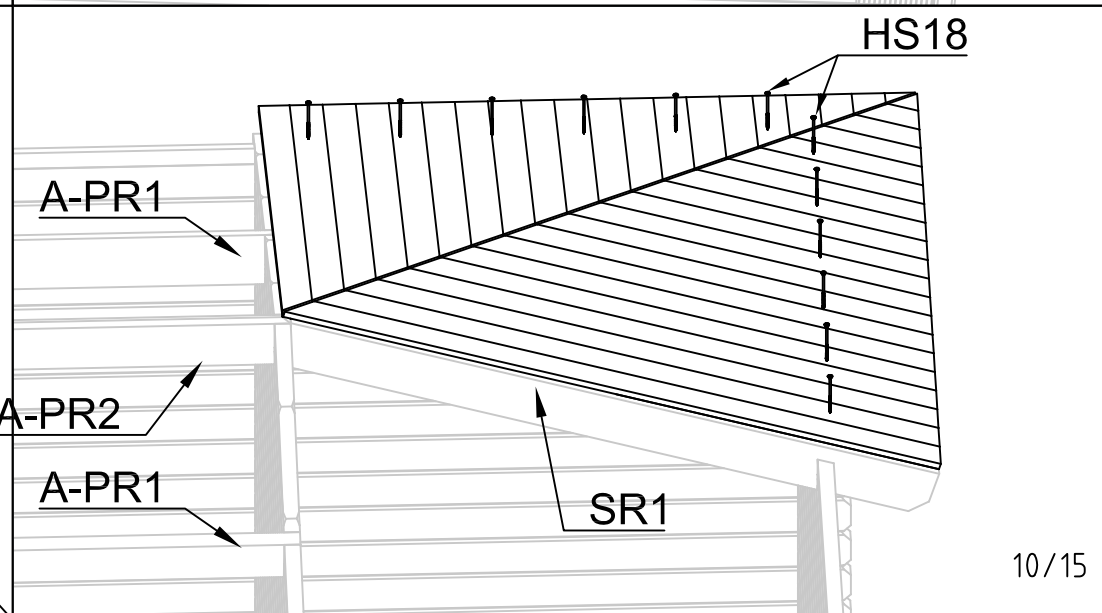
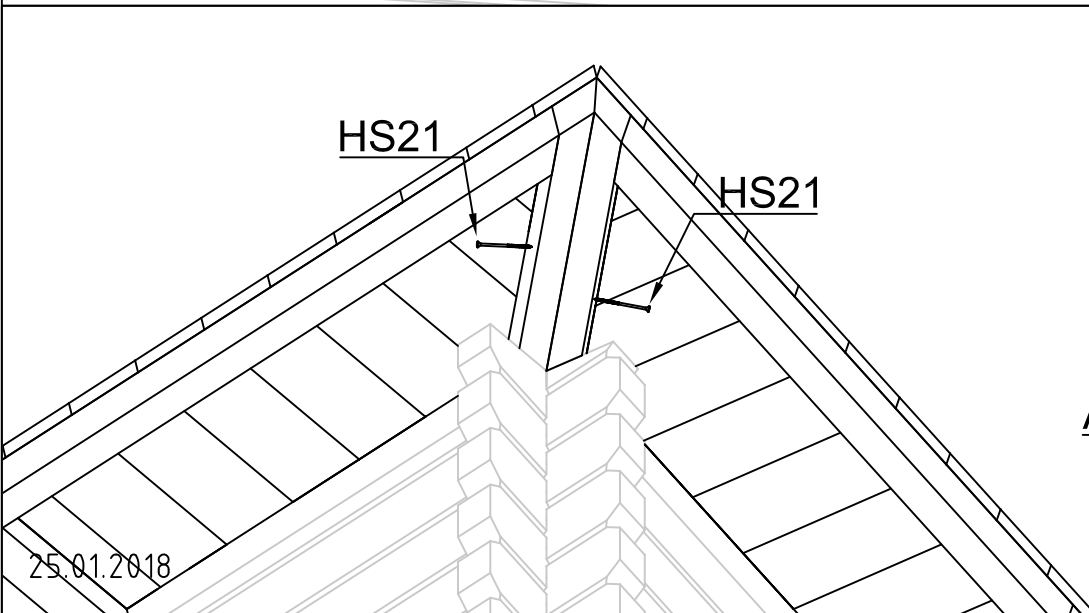
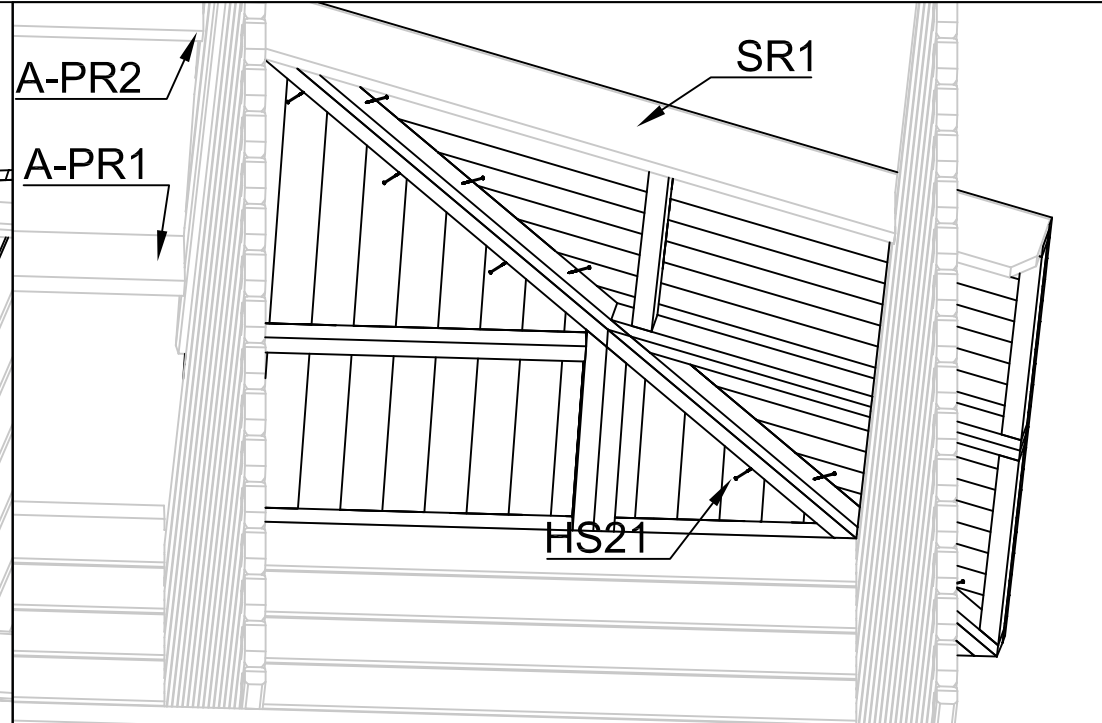
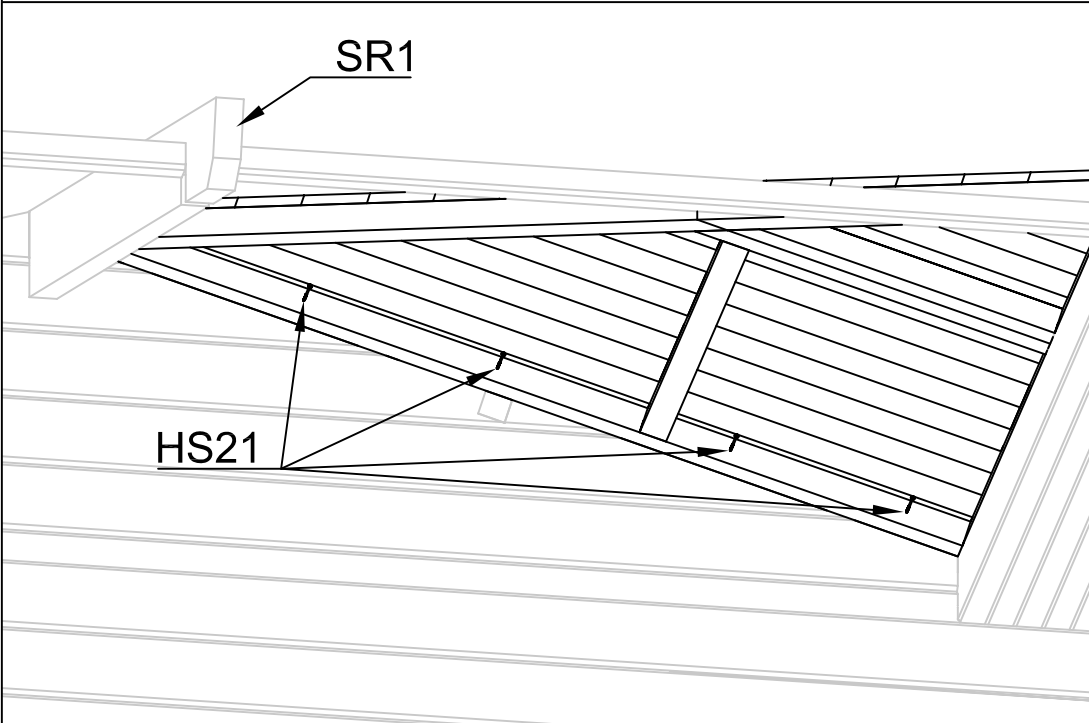

1

Art. Nr. 4014510

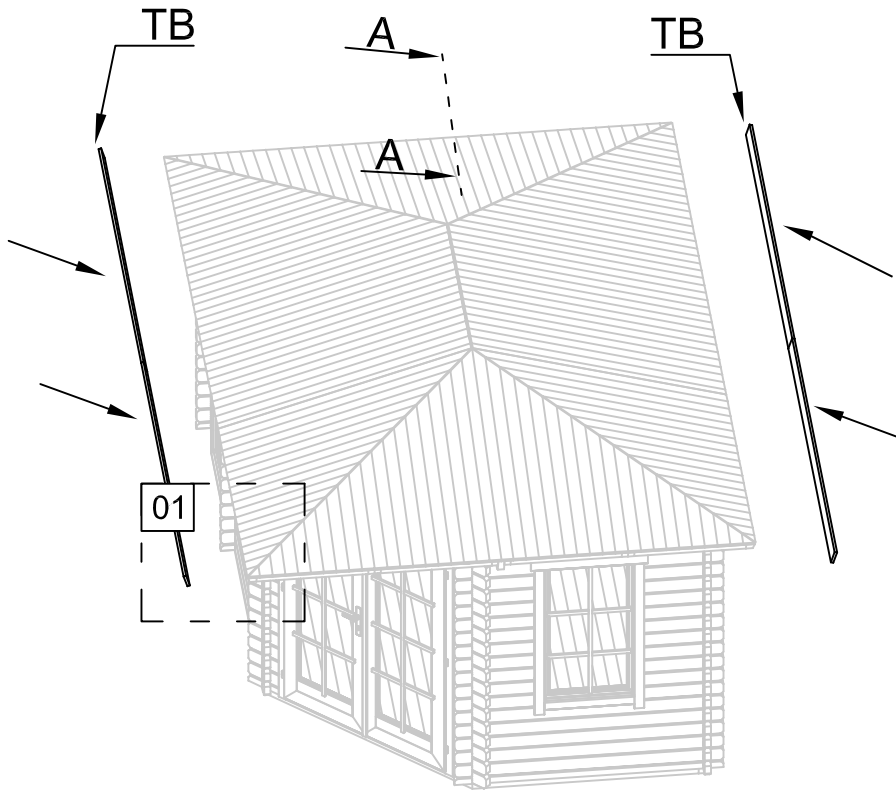

A-A

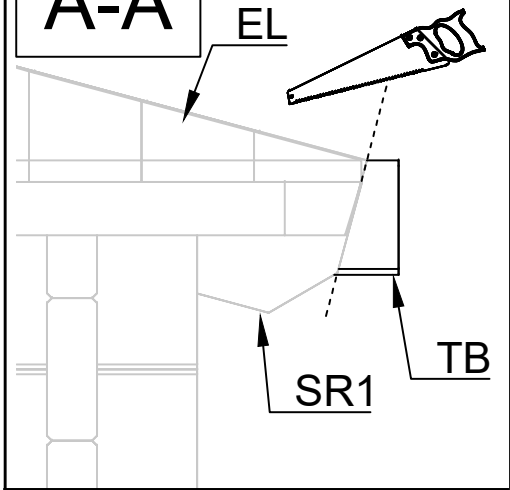

01

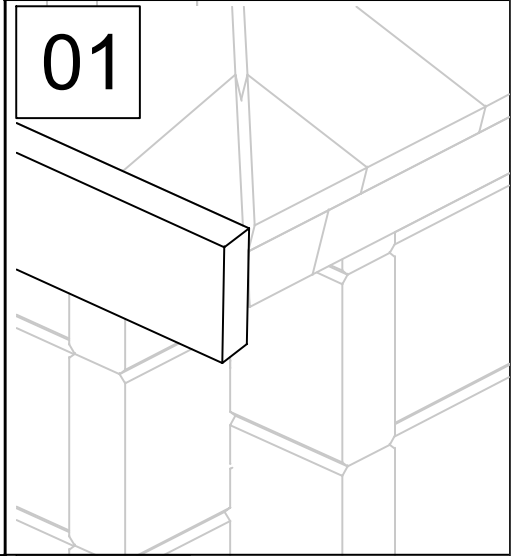

2

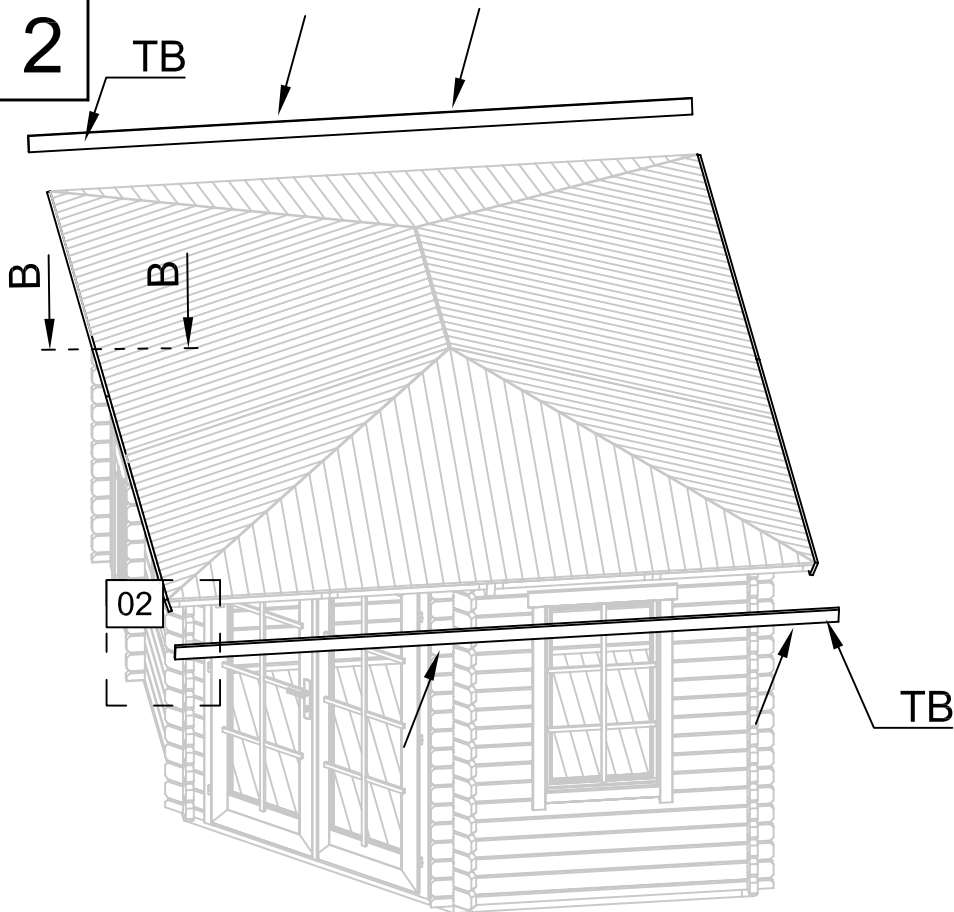



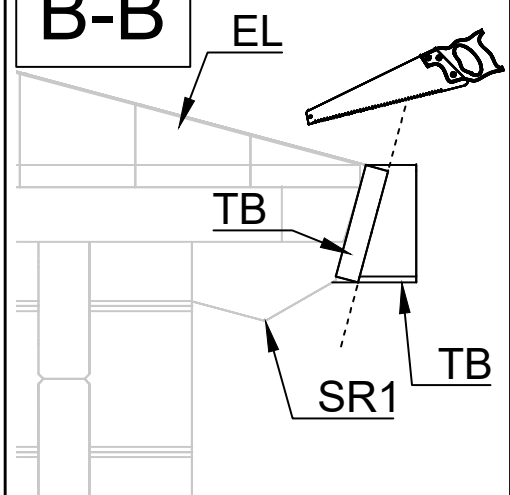



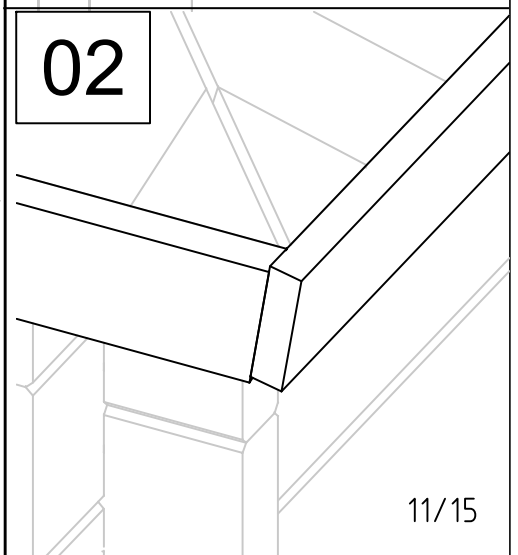

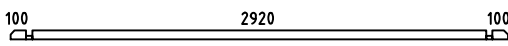
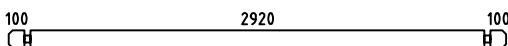
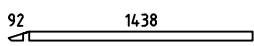
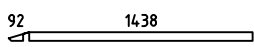
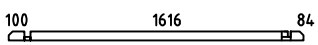
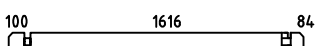

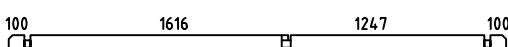
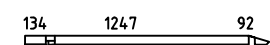
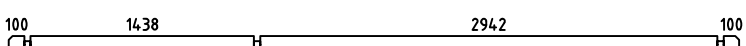
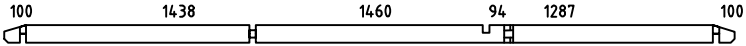

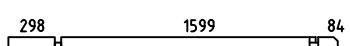
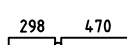

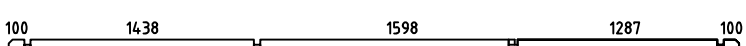
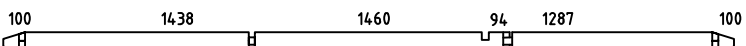

B-B

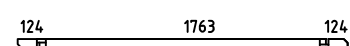

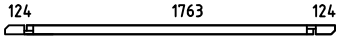
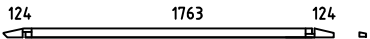
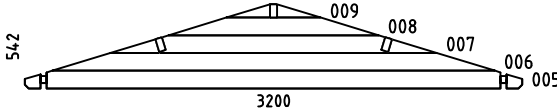
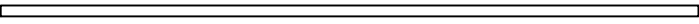
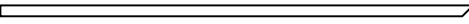
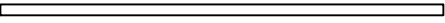
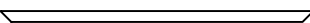
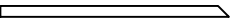

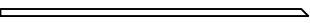
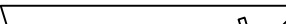

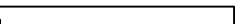
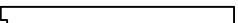
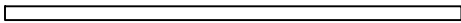
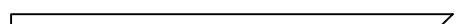

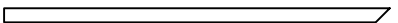
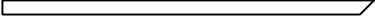

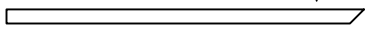
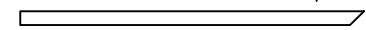
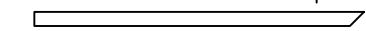
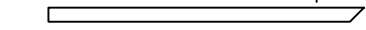
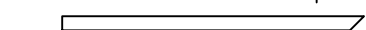

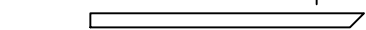
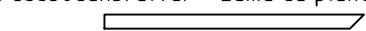
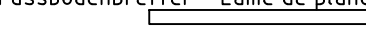
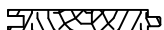

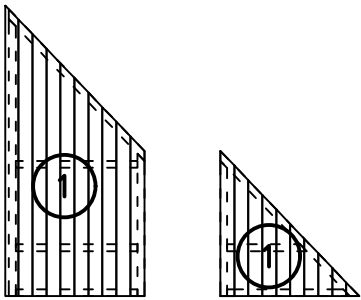
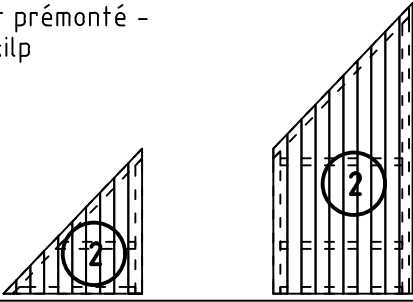

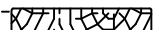
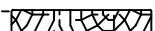



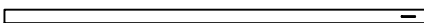
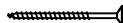
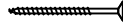
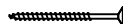



02

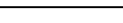

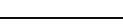

Pos	Piece list - Stückliste - Liste des pièces - Elementi - Stuklijst - Tükítabel 25.01.2018 Art. Nr. 4014510	12/15	Q	P (mm)	L (mm)
001			2	40x57	3200
002			36	40x114	3200
003			1	40x57	1570
004			2	40x57	1570
010			1	40x57	1897
011			6	40x114	1897
012			11	40x114	588
013			11	40x114	588
014			1	40x114	3200
015			1	40x57	1570
016			18	40x114	4700
017			1	40x114	4700
018			17	40x114	436
019			6	40x114	2118
020			11	40x114	808
021			11	40x114	588
022			1	40x114	4700
023			1	40x114	4700
024			1	40x57	310
025			17	40x114	310
026			17	40x114	310
027			1	40x57	310
028			1	40x57	2125



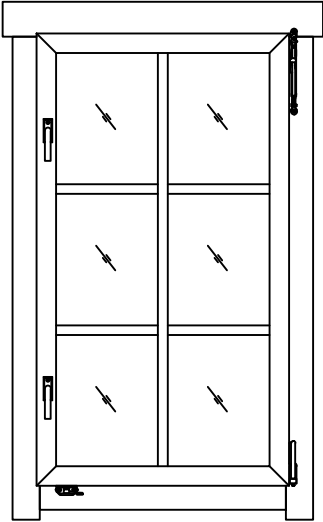
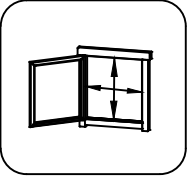
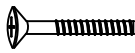
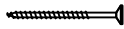

Pos	25.01.2018 Piece list - Stückliste - Liste des pièces - Elementi - Stuklijst - Tükitalabel Art. Nr. 4014510	13/15	Q	P (mm)	L (mm)
029			1	40x57	2125
030			1	40x57	2125
W2-1			1		
IAR1	Foundation - Fundament - Fondation - Fondamenta - Fundering - Immutatud alusraam 		1	70x45	4490
IAR2	Foundation - Fundament - Fondation - Fondamenta - Fundering - Immutatud alusraam 		1	70x45	3137
IAR8	Foundation - Fundament - Fondation - Fondamenta - Fundering - Immutatud alusraam 		1	70x45	2850
IAR4	Foundation - Fundament - Fondation - Fondamenta - Fundering - Immutatud alusraam 		1	70x45	2013
IAR3	Foundation - Fundament - Fondation - Fondamenta - Fundering - Immutatud alusraam 		1	70x45	1567
IAR7	Foundation - Fundament - Fondation - Fondamenta - Fundering - Immutatud alusraam 		7	45x45	2850
IAR6	Foundation - Fundament - Fondation - Fondamenta - Fundering - Immutatud alusraam 		1	45x45	2542
IAR5	Foundation - Fundament - Fondation - Fondamenta - Fundering - Immutatud alusraam 		1	45x45	2054
SR1	Rafter - Dachsparren - Chevron - Trave - Dak spar - Sarikas 		4	44x140	1845
RV1	Lath - Pfetten - Liteau - Piccola asse - Gordingen - Roov 		2	44x44	1460
A-PR2	Roof beam - Dachbalken - Panne de toit - Perlina del tetto - Gordingen / dakbalk - Pärilin 		1	44x140	1544
A-PR1	Roof beam - Dachbalken - Panne de toit - Perlina del tetto - Gordingen / dakbalk - Pärilin 		2	44x140	1500
	Floor boards - Fussbodenbretter - Lamé de plancher - Pavimento - Vloerhout - Põrandalaud 		18	90x18	2938
	Floor boards - Fussbodenbretter - Lamé de plancher - Pavimento - Vloerhout - Põrandalaud 		1	90x18	2931
	Floor boards - Fussbodenbretter - Lamé de plancher - Pavimento - Vloerhout - Põrandalaud 		1	90x18	2841
	Floor boards - Fussbodenbretter - Lamé de plancher - Pavimento - Vloerhout - Põrandalaud 		1	90x18	2751
	Floor boards - Fussbodenbretter - Lamé de plancher - Pavimento - Vloerhout - Põrandalaud 		1	90x18	2661
	Floor boards - Fussbodenbretter - Lamé de plancher - Pavimento - Vloerhout - Põrandalaud 		1	90x18	2571
	Floor boards - Fussbodenbretter - Lamé de plancher - Pavimento - Vloerhout - Põrandalaud 		1	90x18	2481
	Floor boards - Fussbodenbretter - Lamé de plancher - Pavimento - Vloerhout - Põrandalaud 		1	90x18	2391

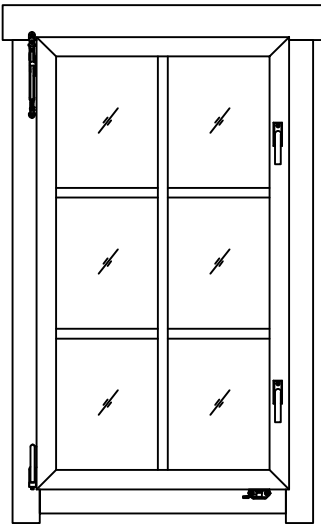
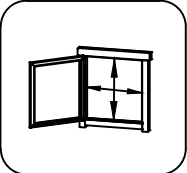

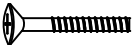
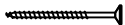

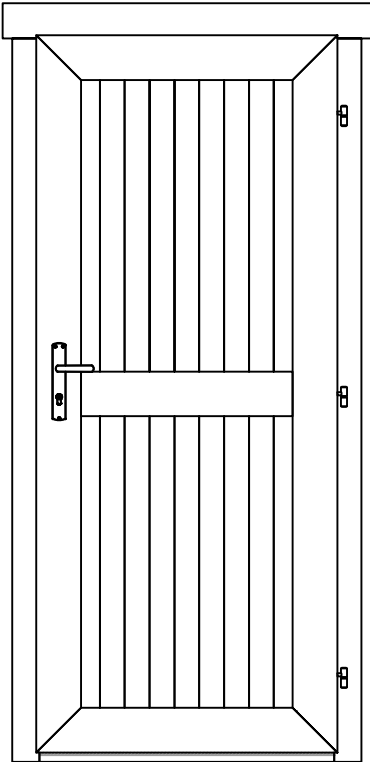
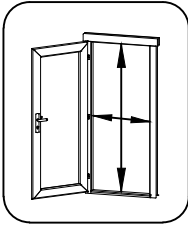

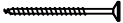
Pos	Piece list - Stückliste - Liste des pièces - Elementi - Stuklijst - Tükitalabel 25.01.2018 Art. Nr. 4014510 14/15	Q	P (mm)	L (mm)
	Floor boards - Fussbodenbretter - Lame de plancher - Pavimento - Vloerhout - Põrandalaud 	1	90x18	2301
	Floor boards - Fussbodenbretter - Lame de plancher - Pavimento - Vloerhout - Põrandalaud 	1	90x18	2211
	Floor boards - Fussbodenbretter - Lame de plancher - Pavimento - Vloerhout - Põrandalaud 	1	90x18	2121
	Floor boards - Fussbodenbretter - Lame de plancher - Pavimento - Vloerhout - Põrandalaud 	1	90x18	2031
	Floor boards - Fussbodenbretter - Lame de plancher - Pavimento - Vloerhout - Põrandalaud 	1	90x18	1941
	Floor boards - Fussbodenbretter - Lame de plancher - Pavimento - Vloerhout - Põrandalaud 	1	90x18	1851
	Floor boards - Fussbodenbretter - Lame de plancher - Pavimento - Vloerhout - Põrandalaud 	1	90x18	1761
	Floor boards - Fussbodenbretter - Lame de plancher - Pavimento - Vloerhout - Põrandalaud 	1	90x18	1671
	Floor boards - Fussbodenbretter - Lame de plancher - Pavimento - Vloerhout - Põrandalaud 	33	90x18	1434
	Roof boards - Dachbretter - Voliges - Perlina per tetto - Dakhout - Katuselaud 	34	90x18	1868
CS	Ceiling shield - Element - Panneau de toiture - Pannelo del soffitto - Plafond bedeking - Laekilp 	1		
EL	Roof element - Dachelement - Panneau de toit prémonté - Componente del tetto - Dakelement - Katusekilp 	4		
EL	Roof element - Dachelement - Panneau de toit prémonté - Componente del tetto - Dakelement - Katusekilp 	4		
	Floor fillet - Fussbodenleiste - Corniere de finition du plancher - Finitura per pavimento (battisco pa) - Vloerafwerklijst - Põrandaliist 		18x18	19.64
TB1	Fascia board - Traufbrett - Bandeau de toit - Finitura lati tetto - Gevellijst Räästalaud 	4	18x90	2587
TB-2	Fascia board - Traufbrett - Bandeau de toit - Finitura lati tetto - Gevellijst Räästalaud 	2	18x90	3674

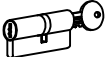
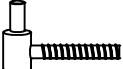
Pos	Piece list - Stückliste - Liste des pièces - Elementi - Stuklijst - Tükitalabel 25.01.2018 Art. Nr. 4014510	15/15	Q	P (mm)	L (mm)
DRV-1	Roof edge reinforcement - Dachrandverstärkung - Corniere de renfort de bord de toit - Rinforzo x tetto - Dakrand versterking - Räästatugevdus 		2	44x44	1478
KFS-1	Storm protection - Sturmleiste - Latte anti-tempete - Protezione anti vento - Stormverankering / beveiliging - Tormikinnitusliist 		5	22x45	2500
HS16	Screw for roof lath - Schraube für dachlatte - Vis pour latte - Vite per listello del tetto - Schroef voor daklat - Kruvi roovile 		6	5x90	
HS12	Screw for fascia boards - Schrauben für traufbretter - Vis pour fixation bandeau de toit - Viti x striscia del tetto - Schroef voor gevellijst - Kruvi räästalaualae 		40	4x40	
HS13	Screw for roof edge reinforcement - Schrauben für dachrandverstärkung - Vis pour fixation corniere renfort de bord de toit - Viti x rinforzo bordo tetto - Schroef voor dakrand versterking - Kruvi räästatugevdusele 		8	4x60	
HS18	Screw for foundation - Schrauben zur befestigung fundament - Vis de fixations des poutrelles de fondations - Viti x fondamenta - Schroef voor fundering - Kruvi alusraamile 		22	5x120	
HS18	Screw for fixing roof elements - Schraube für befestigung dachelementen - Vis de fixation des panneaux de toit - Vite per fissare gli elementi del tetto - Schroef voor bevestiging dakelement - Kruvi kilpide kinnitamiseks seinaga 		48	5x120	
HS18	Screw for roof beams - Schrauben für dachbalken - Vis pour fixation pannes de toit - Viti per perline del tetto - Schroef voor gordingen / dakbalken - Kruvi pärlinitele 		19	5x120	
HS18	Screw for gable - Schrauben für giebel - Vis pour fixation des pignons - Viti per timpano - Schroef voor gevelpunt - Kruvi viilude kinnitamiseks 		5	5x120	
HS16	Screw for 1. wall beam - Schraube für 1. bohlenreihe - Vis de fixations 1ere rangée de madriers avec poutrelles de fondations - Vite fissaggio alle fondamenta - Schroef voor 1 wandbalk - Kruvi poollauale 		10	5x90	
HS16	Screw for foundation - Schrauben zur befestigung fundament - Vis de fixations des poutrelles de fondations - Viti x fondamenta - Schroef voor fundering - Kruvi alusraamile 		2	5x90	
HS21	Screw for fixing roof elements - Schraube für befestigung dachelementen - Vis de fixation des panneaux de toit - Vite per fissare gli elementi del tetto - Schroef voor bevestiging dakelement - Kruvi kilpide montaažiks 		120	6x80	
NF2	Zn nail for floor fillet - Zn nägel für fussbodenleiste - Pointe pour corniere de finition du plancher - Chiodi x fissaggio pavimento - Spijker(nagel) voor vloer afdekljst - Nael põrandaliistule 		39	1.4x40	
SH40	Hammer block - Schlagholz - Calle de frappe - Blocco di legno da usare come cuscinetto quando si usa il martello - Slagklos - Löögiklots 		1		
SFS	Nut for storm protection - Schraubenmutter für sturmleiste - Ecrou pour latte anti-tempete - Dado x asta protezione vento - Moer voor stormverankering - Mutter tormikinnitusliistule 		10	D6	
NF4	Zn nail for roof - Zn nägel für dachbretter - Pointe pour fixation voliges de toit - Chiodi x perline tetto - Spijker(nagel) voor dakhout - Nael katuselauale 		120	2x50	
NF4	Zn nail for floor - Zn nägel für fussbodenbretter - Clous pour plancher - Chiodi x perline pavimento - Spijker(nagel) voor vloer - Nael põrandalaualae 		361	2x50	
BFS	Bolt for storm protection - Bolzen für sturmleiste - Boulon pour latte anti-tempete - Bullone x asta protezione vento - Bout voor stormankerlat - Puidupolt tormikinnitusliistule 		10	6x70	
DFS	Washer for storm protection - Dichtscheibe für sturmleiste - Rondelle pour latte anti-tempete - Rondella x asta protezione vento - Afdichtring voor storm strip - Seib tormikinnitusliistule 		10	D6	
	Window - Fenster - Fenetre - Finestra - Raam - Aken	710x1224 AK.1.106.TSSP SGC	1		
	Window - Fenster - Fenetre - Finestra - Raam - Aken	710x1224 AK.1.106.TSSV SGC	1		
	Door - Tür - Porte - Porte - Deur - Uks	835x1900 UL.2.100.IVP.MMd TC	1		
	Door - Tür - Porte - Porte - Deur - Uks	1494x1957 TUK.1.108.TSVP.MMb SGC	1		

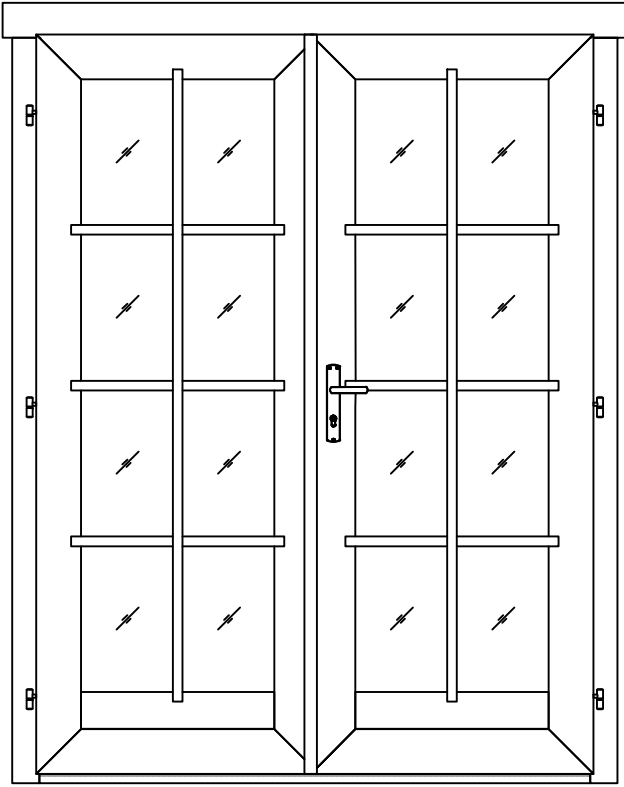
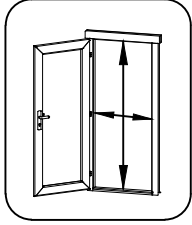
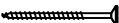
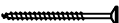
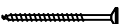
Pos	24.11.2017 Piece list - Stückliste - Liste des pièces - Elementi - Stuklijst - Tükitalabel 710x1224 AK.1.106.TSSP SGC	1/1	Q	P (mm)	L (mm)
	<p data-bbox="260 145 1292 174">Glass size - Glasgröße - Taille de la vitre - Misura del vetro - Glas afmeting - Klaasi mõõt: 566x1080 mm</p>   <p data-bbox="1369 342 1492 371">610x1124 mm</p>				
FS1	<p data-bbox="260 1948 1021 2004">Window handle fittings - Fenstergriff - Poignée de fenetre - Maniglia c/ferramenta - Raamhendel -/grendel -/klink - Aknalink</p>		2		
FSP	<p data-bbox="260 2027 1101 2105">Bolt for window handle fittings - Bolzen für fenstergriff beschlag - Vis pour fixation poignée de fenetre - Bullone x apertura manuale finestra - Schroef voor raamhendel - Akna käepideme polt</p>		4		
HS1	<p data-bbox="260 2116 1109 2195">Screw for georgian bars - Schraube für sprossen - Vis pour croisillons - Viti per unire la griglia georgiana della finestra - Schroeven voor raamverdeling - Krugi akna petfeliistule</p>		6	2.5x20	

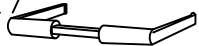
Pos	24.11.2017 Piece list - Stückliste - Liste des pièces - Elementi - Stuklijst - Tükítabel 710x1224 AK.1.106.TSSV SGC	1/1	Q	P (mm)	L (mm)
	<p data-bbox="260 152 1292 183">Glass size - Glasgröße - Taille de la vitre - Misura del vetro - Glas afmeting - Klaasi mõõt: 566x1080 mm</p>   <p data-bbox="1369 347 1492 376">610x1124 mm</p>				
FS1	<p data-bbox="260 1953 1021 2004">Window handle fittings - Fenstergriff - Poignée de fenetre - Maniglia c/ferramenta - Raamhendel -/grendel -/klink - Aknalink</p>			2	
FSP	<p data-bbox="260 2033 1101 2110">Bolt for window handle fittings - Bolzen für fenstergriff beschlag - Vis pour fixation poignée de fenetre - Bullone x apertura manuale finestra - Schroef voor raamhendel - Akna käepideme polt</p>			4	
HS1	<p data-bbox="260 2123 1109 2199">Screw for georgian bars - Schraube für sprossen - Vis pour croisillons - Viti per unire la griglia georgiana della finestra - Schroeven voor raamverdeling - Krugi akna petfeliistule</p>			6	2.5x20

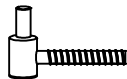
Pos	13.01.2017	Piece list - Stückliste - Liste des pièces - Elementi - Stuklijst - Tükitalabel 835x1900 UL.2.100.IVP.MMd TC	1/1	Q	P (mm)	L (mm)
		  <p>735x1818 mm</p>				
HS25	Screw for doorstep - Schrauben für swelle - Vis pour fixation barre de seuil - Vite per soglia della porta - Schroef voor deurdorpel - Kruvi lävepakule		2	4.5x65		
HS16	Screw for door jamb - Schraube für Türrahmen - Vis de fixation partie haute avec montants du cadre de porte - Viti x fissaggio montanti porte - Schroef voor deurkozijn - Kruvi ukse lengile		4	5x90		
TL4	Door handle fittings - Türgriff - Poignée de porte - Maniglie - Deurhendel / klink - Ukse käepide		1			
TL5	Set of door lock covers - Schlossblenden - Set de garnitures de porte - Copertura serrature - Slot sluitplaat set - Ukse lukuplaat		1			
	Cylinder lock - Zylinderschloss - Barillet de porte - Serratura - Cylinder slot - Ukse lukusüdamik		1	30x35		
	Male bolt hinge for door - Türband - Partie male de paumelle de porte - Cerniera anube x porta - Scharnier bout - Ukse polthing isane		3			

Pos	24.11.2017	Piece list - Stückliste - Liste des pièces - Elementi - Stuklijst - Tükítabel 1494x1957 TUK.1.108.TSVP.MMb SGC	1/1	Q	P (mm)	L (mm)
		Glass size - Glasgröße - Taille de la vitre - Misura del vetro - Glas afmeting - Klaasi mõõt: 514x1593 mm				
		  <p>1394x1873 mm</p>				
HS1	Screw for georgian bars - Schraube für sprossen - Vis pour croisillons - Viti per unire la griglia georgiana della finestra - Schroeven voor raamverdeling - Kruvi ukse peffeliistule		16	2.5x20		
HS4	Screw for door fillet - Schraube zur befestigung türleiste - Vis pour fixation baguette d'arret de porte - Viti per massellino della porta - Schroef voor deurlijst - Kruvi ukse kokkuvaltssiliistule		5	3x30		
HS16	Screw for door jamb - Schraube für türrahmen - Vis de fixation partie haute avec montants du cadre de porte - Viti x fissaggio montanti porte - Schroef voor deurkozijn - Kruvi ukse lengile		4	5x90		
HS25	Screw for doorstep - Schrauben für swelle - Vis pour fixation barre de seuil - Vite per soglia della porta - Schroef voor deurdorpel - Kruvi lävepakule		3	4.5x65		
TL4	Door handle fittings - Türgriff - Poignee de porte - Maniglie - Deurhendel / klink - Ukse käepide		1			
TL5	Set of door lock covers - Schlossblenden - Set de garnitures de porte - Copertura serrature - Slot sluitplaat set - Ukse lukuplaat		1			
	Cylinder lock - Zylinderschloss - Barillet de porte - Serratura - Cylinder slot - Ukse lukusüdamik		1	30x35		
	Male bolt hinge for door - Türband - Partie male de paumelle de porte - Cerniera anube x porta - Scharnier bout - Ukse polthing isane		6			
	Striker for barrel bolt - Hülse für grendelriegel - Gache au sol du targette - Boccola per fermo della porta - Huls voor vergrendelingsschuif - Vasturaud ukse servariivile		2			